



**MAXCO**

Industrial Chains and Sprockets

We provide more than chain...  
**WE PROVIDE RELIABILITY**

**With over 100 years of experience, MAXCO Chain has developed Product Solutions for the most demanding applications**

**FREEDON SERIES**  
SELF-LUBRICATING ROLLER CHAIN

**SEAL GUARD**

**PERFECT COAT PLUS II**

**MEGA CHAIN**  
STAINLESS STEEL

Maintenance Free  
Operation

Environmental  
Resistance

**Poly Steel Chain**

**Environmental  
Products Group**

**MC**  
**MAXCO**

Strength and  
Wear Life

**Chromium Pin Chains**

**INSPIRE  
SERIES SBR**

**Attachment Chain**

**Double Capacity Chain**

In 1987 we started manufacturing the first premium line of fully solid bushing-solid roller (SBR®) industrial roller chain products. Today our Inspire Series SBR® are the highest rated roller chains in the world.

Information on additional products can be found at  
[www.maxcochain.com](http://www.maxcochain.com)

# Maintenance Free Operation



**Maintenance Free Operation**  
now possible for Heavy duty  
roller chain drives

**Newly developed, patent pending; SEAL GUARD™ Roller Chains from MAXCO CHAIN extend the benefits of maintenance free operation to larger pitch heavy duty roller chain drives.**

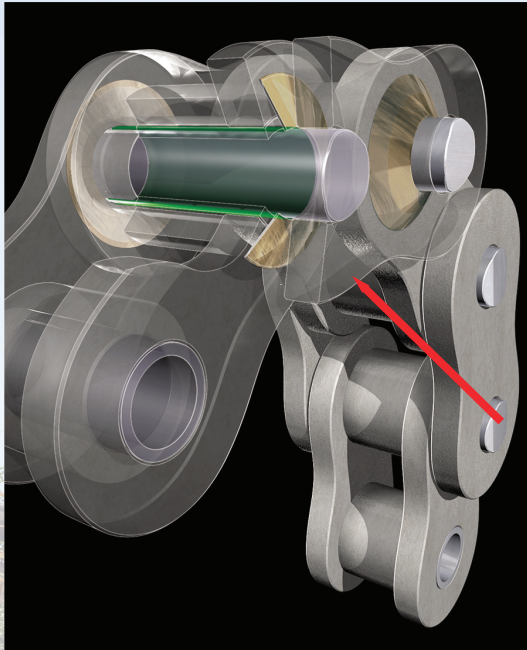

Construction, mining, shot blast equipment, as well as a broad range of heavy duty roller chain applications can now utilize large pitch roller chain - Sizes 60 (3/4" pitch) thru 240 (3" pitch) and enjoy the significant benefits of maintenance free operation. The unique stainless steel contact seals, installed between the link plates, retains a high quality bearing grease inside the chain joint, keeping out damaging abrasives such as grit and other debris that decrease chain life.

**Unique stainless steel spring type contact seals fitted between link plates prevent penetration of abrasive materials while sealing in high quality bearing lubricant minimizing elongation due to chain wear**

SEAL GUARD™ Roller Chains are available with a variety of corrosion resistant coatings. Our unique Inspire Series™ stainless steel blast coating is standard finish, optional black oxide or our Perfect Coat Plus® surface treatments offer significant added protection against external chain corrosion.



Freedom Series® Self-Lubricating chains offer premium performance and value in a sintered maintenance free product. It features the addition of a roller for reduced friction, smoother operation over sprockets, and specially coated pins and link plates for rust prevention and improved wear life. They are available in PT-Type, for most drive or power transmission applications, and C-Type, for conveyor applications. Nickel plate or Perfect Coat Plus™ are also available.

The PT-Type chains are made with slightly modified dimensions to achieve the same strength and working load values as ASME/ANSI standard chains (unlike standard SL-Series products which possess reduced ratings). This allows them to be direct replacements on many slow to moderate speed drives. These chains are available in single strand only and will operate on standard ASME/ANSI sprockets.

**Normal Operating Temperature 4°F to 158°F**  
**Also available in Nickel Plate or Perfect Coat Plus™**

# Strength and Wear



**MAXCO CHAIN Inspire Series™ SBR® chains are the highest rated standard roller chains in the world.**

Stainless Steel Blast Treatment Components of our new INSPIRE SERIES® SBR® roller chains are coated with a film of stainless steel achieved through a proprietary blast treatment.

The film works with the high quality pre-lubricant to protect the chain from corrosive attack and extend life. The blast also gives the chain an enhanced silver color appearance.

## Features Summary:

45%-50% Higher Fatigue Strength Highest Rated Roller Chains in the World Higher Horsepower Capacities New Ultra-high Hardness Shell On Bearing Parts Unique Stainless Steel Blast Treatment Solid Bushings and Solid Rollers Special Boron Steel Pins on select sizes

## Benefits Summary:

Greater resistance to fatigue failure. Longer wear life due to high hardness shell. Smaller chain sizes required (Higher HP ratings). Corrosion protection from proprietary stainless blast.

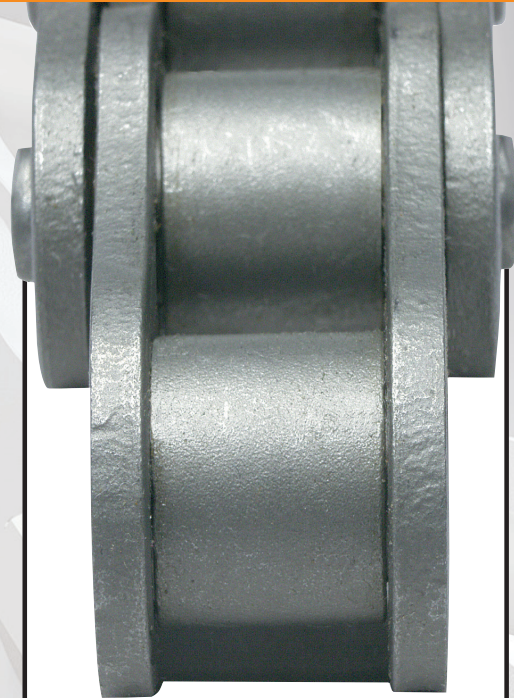

**The Difference is  
New PATENTED  
Production Technology...**

The Production Process  
Raw Material - High Quality Alloy Steel.  
Parts Fabrication.  
Heat Treatment.  
Hi-Energy Mechanical Process (Pat.).  
Stainless Steel Blast (Pat. Pend.).  
Assembly.  
Pre-Lubrication.  
Packaging.  
Shipping.



## ATTACHMENT CHAIN

MAXCO CHAIN Inspire Series SBR® attachment chains are available in a wide array of sizes and configurations. Built in our strategically located service centers in Marietta, GA and Portland, OR these premium series products are available for fast delivery (24-72 hours).







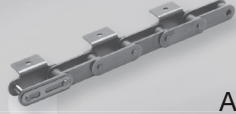

We stock both standard and the hard to get non-standard wide contour and double lug attachments in both carbon and stainless steels. These chains are appropriate for use in a variety of industries and applications.

MAXCO CHAIN is committed to keeping users up and running with the best combination of delivery and performance available anywhere.

**CHECK OUT THE VARIETY AVAILABLE**

# Attachment Chain Nomenclature

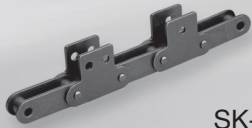
## Standard Attachments

| Type      | Description   | ASME/ANSI Standard   | Double Pitch   |
|-----------|---|--|--|
| <b>A</b>  | Bent Lug One Side<br>A-1: One Hole<br>A-2: Two Holes              |  A-1          |  A-1 or A-2   |
| <b>K</b>  | Bent Lug Both Sides<br>K-1: One Hole<br>K-2: Two Holes            |  K-1          |  K-1 or K-2   |
| <b>SA</b> | Straight Lug One Side<br>SA-1: One Hole<br>SA-2: Two Holes        |  SA-1         |  SA-1 or SA-2 |
| <b>SK</b> | Straight Lug Both Sides<br>SK-1: One Hole<br>SK-2: Two Holes      |  SK-1         |  SK-1 or SK-2 |
| <b>D</b>  | Extended Pins<br>D-1: One Pin Extended<br>D-3: Both Pins Extended |  D-1 or D-3 |  D-1 or D-3  |

## ASME/ANSI Specialty Attachments

|            |   |   |   |
|------------|---|---|---|
| <b>WA</b>  | Wide Contour Bent Lug One Side<br>WA-1: One Hole<br>WA-2: Two Holes         |  WA-1  |  WA-2  |
| <b>WK</b>  | Wide Contour Bent Lug Both Sides<br>WK-1: One Hole<br>WK-2: Two Holes       |  WK-1  |  WK-2  |
| <b>WSA</b> | Wide Contour Straight Lug One Side<br>WSA-1: One Hole<br>WSA-2: Two Holes   |  WSA-1 |  WSA-2 |
| <b>WSK</b> | Wide Contour Straight Lug Both Sides<br>WSK-1: One Hole<br>WSK-2: Two Holes |  WSK-1 |  WSK-2 |
| <b>AA</b>  | Double Lug Bent Top & Bottom One Side<br>AA-1: One Hole                     |  AA-1  |   |
| <b>KK</b>  | Double Lug Bent Top & Bottom Both Sides<br>KK-1: One Hole                   |  KK-1  |   |

# Environmental Resistance/EPG



*Perfect Coat Plus II™ chains offer up to thirty times more protection from corrosive damage compared with conventional nickel plated products. These improved chains feature a Hexavalent Chromium Free mechanical rust prevention system which utilizes a ROHS compliant, zinc-alloy-iron film coating. The resulting film is extremely durable and will not chip, flake, peel or rust in many mildly corrosive applications.*

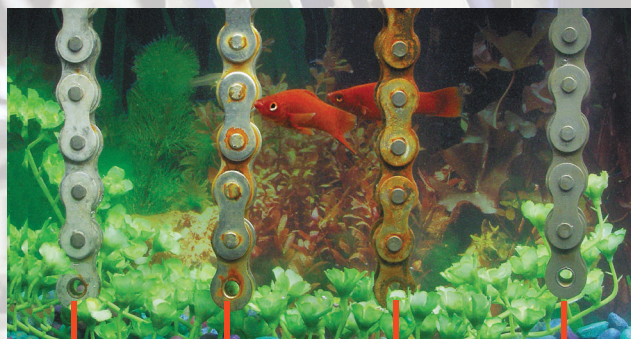

Traditional  
Dip-Spin  
Zinc-Chrome  
Coating

Nickel Plated

Carbon Steel

Perfect Coat  
Plus II™

## A Mechanical Rust Prevention System

MAXCO CHAIN Perfect Coat PlusII™ chains utilize a unique dual coating, mechanical rust prevention system, consisting of a zinc alloy blast and a non-aqueous di-chromate sealing solution. This coating is ideally suited for mildly corrosive, moisture related applications such as wash down lines on conveyors, outdoor service or other similar uses.

As with all platings including nickel, zinc or cadmium, Perfect Coat Plus II™ is NOT FDA approved for direct contact with food products. It can however be used in the food and beverage industry where the chain does not directly contact food products, but where resistance to rust is required.

### ADVANTAGES:

- 30 times more corrosion protection compared with nickel plating.
- Ultimate strength and working load ratings are the same as carbon steel chains.
- The possible occurrence of hydrogen embrittlement is eliminated.
- More economical compared with stainless steel.

## Poly Steel Chain

Sanitary and lightweight MAXCO's Poly-steel (PS) chains are found most often in food processing and the pharmaceutical industry. They are made from a combination of AISI type 304 stainless steel pins and link plates and engineered plastic inside block links.

These chains are generally maintenance free and can replace 304 stainless steel chains in many applications. An FDA approved food grade plastic (Blue color) is available in the case of direct contact with food products on a made-to-order basis.

- Special Connecting Links for 25PS and 35PS required.
- Standard 304SS Connecting Links for 40PS - 60PS.
- Allowable temperature range -40 F to 1760 F (-200 C to 800 C).
- Maximum chain speed: 230 ft/min (70.1 m/min).
- Allowable PH range 4PH - 9PH.





## Take a new look at an old product...

We've totally re-engineered the traditional stainless steel roller chain product in order to achieve unparalleled strength and wear performance. Now, incredibly, these chains possess ultimate strength ratings which challenge even the best carbon steel products. Wear performance has been increased by 35%-50% due to larger bearing areas and a unique labyrinth seal design.

### DUAL FUNCTION LINK PLATE CONSTRUCTION

Inside and outside link plates work together to improve strength and wear life in two important ways.

1. The "cap" portion of the outer plate engages the flanged portion of the inside plates under load to significantly improve both ultimate and fatigue strength. The improvement is so dramatic that these chains possess ultimate strength ratings which challenge even the best of the premium carbon steel brands.
2. The unique construction provides a labyrinth seal which helps to protect the pin/bushing wear area from abrasive particles and debris while allowing the penetration of lubricant. This feature, in combination with a larger pin/bushing bearing area, improves wear performance by 35%-50%.

### MEGA CHAIN CONSTRUCTION

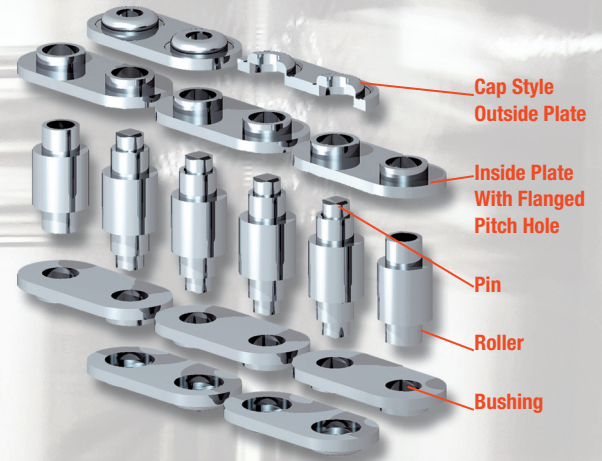

**ALL PARTS ARE MADE FROM AISI 304 AUSTENETIC STAINLESS STEEL FOR EXCELLENT HEAT AND CORROSION RESISTANCE.**

## Environmental Products Group

MAXCO CHAIN, Ltd. offers a wide variety of products and components for use with every type of wastewater treatment facility equipment. Our extensive research into manufacturing methods plus many field tests conducted at plants across the nation has resulted in products of proven safety and quality. We accept the challenge of commitment to our demonstrated design expertise and product innovation.

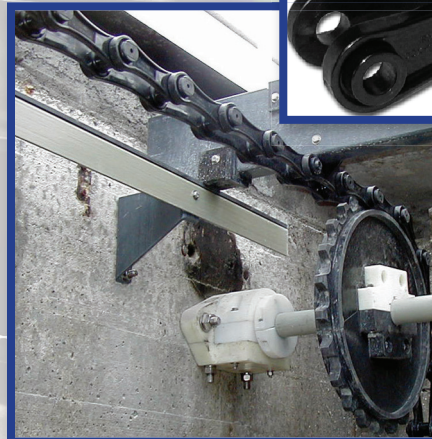



**MAXCO**  
Industrial Chains and Sprockets

# SPROCKETS



Whatever the environment  
**Maxco Chain** has the  
right sprocket for you.  
Maxco's trained sales staff  
has the knowledge and  
experience to find the right sprocket  
for your application.

**Call and Experience the difference...**

35 - 100 pitch  
B Hub  
Plain Bore  
Taper Lock  
QD  
All Solid Construction  
All Hardened Teeth

**Maxco Chains 1-800-241-8209**

[www.maxcochain.com](http://www.maxcochain.com)